



User Manual

A100 / A200 / A300 Optical Fibre Probe



Copyright (C) Dipl.-Ing. Gunter Langer
Näthnitzer Hang 31
01728 Bannewitz
17.01.2000

Voltage measurement and oscillographic signal tracing in devices and systems under extreme electromagnetic conditions.

Contents:	Page
1 Usage	3
1.1 Measurement under interference conditions	3
1.2 EMC tests as the main field of application	3
1.3 Measured signals	3
1.4 Specific measurement technology	3
1.5 Specific measuring task	3
1.6 Examples of disturbed useful signals	4
2 Function	6
2.1 Method of measurement	6
2.2 AS XXX ADC probe (sensor)	6
2.3 AE XXX DAC receiver	6
3 Operation	7
3.1 Connection of the probe (example AS 100) to the DUT	7
3.2 Starting the AE XXX optical receiver	8
4 Safety instructions	9
5 Warranty	9
6 Technical data	10
6.1 System	10
6.2 Sensors	10
6.3 Receivers	10
7 Scope of delivery	11
7.1 A100-1 / A200-1 / A300-1 (1-channel) set	11
7.2 A100-2 / A200-2 / A300-2 (2-channels) set	12

1 Usage

1.1 Measurement under interference conditions

Measurement of analog electrical signals under extreme electromagnetic stress such as:

- Coupling of radiated or conducted RF emissions
- Fast transients burst / ESD
- High potential (high voltage)

1.2 EMC tests as the main field of application

- Radiated RF emissions EN 61000-4-3:
80 MHz-1 GHz, 80 % AM (1 kHz), anechoic chambers TEM cells stripline,
- Conducted RF emissions EN 61000-4-6:
40 V_{eff}, 150 kHz-230 MHz, 80 % AM (1 kHz)
- Burst EN 61000-4-4
- ESD EN 61000-4-2

1.3 Measured signals

- Supply voltages (switching controllers, linear controllers),
- Reference voltages,
- Digital signals (optical couplers, optical receivers),
- Analog signals (operational amplifiers, ADC, DAC).

1.4 Specific measurement technology

To measure analog signals under extreme interference conditions, measurement technology is needed that

- a) itself is not affected by disturbance fields and thus does not simulate any disturbance in the equipment under test (DUT),
- b) can be connected to the DUT in a decoupled way, i.e. connecting the probe head does not result in the development of additional disturbance current paths through which disturbances can penetrate or be discharged.

The A100 / A200 / A300 optical fibre measurement systems meet these demands.

1.5 Specific measuring task

Analog electronic modules are generally influenced in EMC tests when RF, modulated by 1 kHz, is applied to the DUT. This influence is due to the fact that the infiltrated RF disturbance is demodulated at PN junctions of the electronic circuit. This generates signal level fluctuations or 1 kHz disturbance signals. The 1 kHz disturbance signal is produced through modulation of the RF disturbance by 1 kHz.

Relatively slow disturbance signals with a fundamental wave of 1 kHz, which mostly interfere with analog circuits, are characteristic for RF disturbance coupling.

Figure 1 to Figure 6 on the following pages shows examples of useful signals that were subjected to disturbances. The deviation of the signal form from the sine wave varies, i.e. the disturbance signal also contains a harmonic component as well as the fundamental one. The task is to correctly measure these relatively slow disturbance signals under extreme RF interference conditions.

The A100 / A200 / A300 measurement systems are ideal for these conditions because of their high disturbance immunity.

1.6 Examples of disturbed useful signals

- Signals were measured with the AS 100 optical fibre probe
- Radiated RF emissions: 250 MHz, 80 % amplitude-modulated by 1 kHz
- DUT: operational amplifier circuit; RF coupling via an operational amplifier input; the disturbance signal was measured on the output.

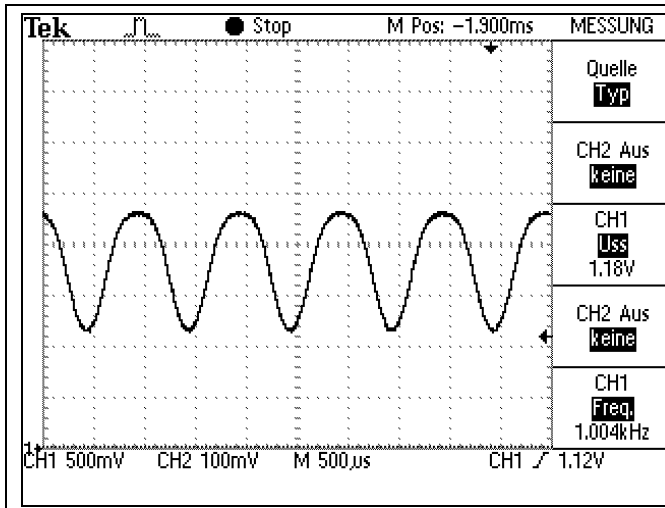

Figure 1 The oscillogram shows a constant useful signal with a demodulated 1 kHz component.

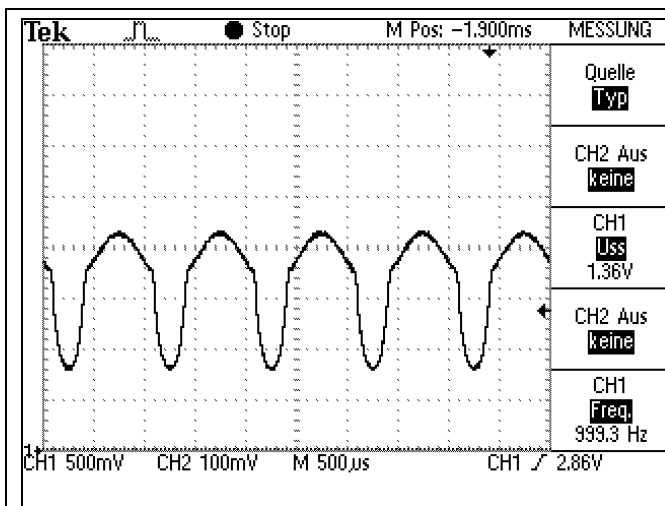

Figure 2 The demodulated 1 kHz disturbance signal, superimposed on the useful signal, shows a large harmonic component.

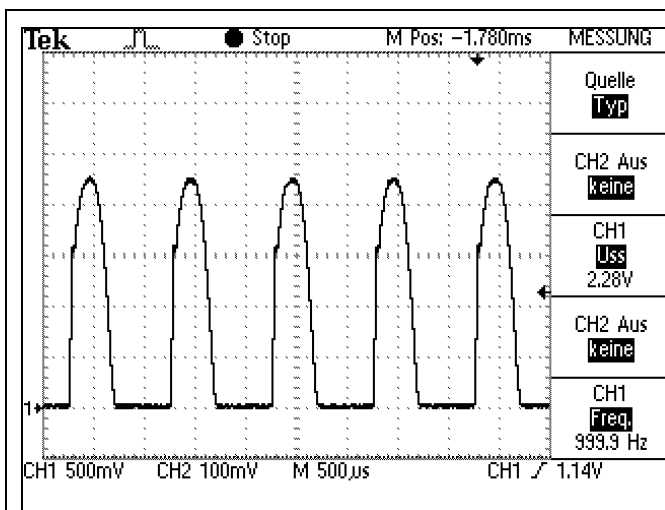

Figure 3 The demodulated 1 kHz disturbance signal is limited by the lower rail.

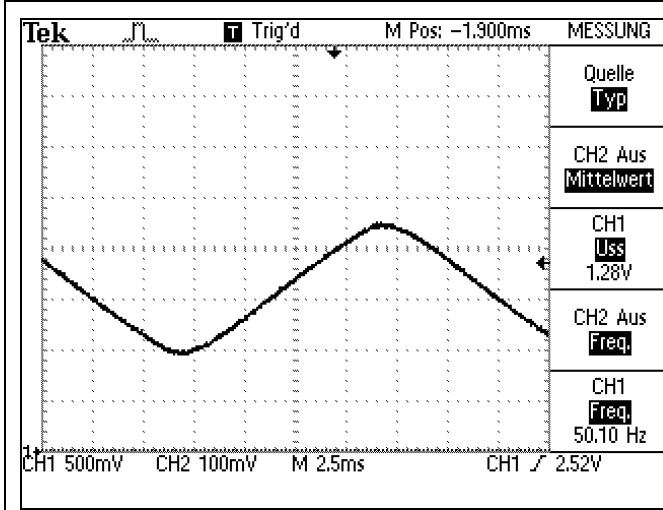

Figure 4 Useful signal without interference

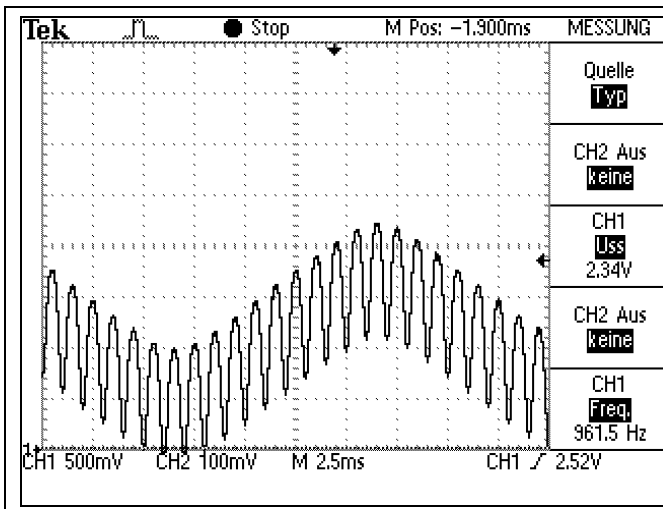

Figure 5 Useful signal with 1 kHz disturbance signal

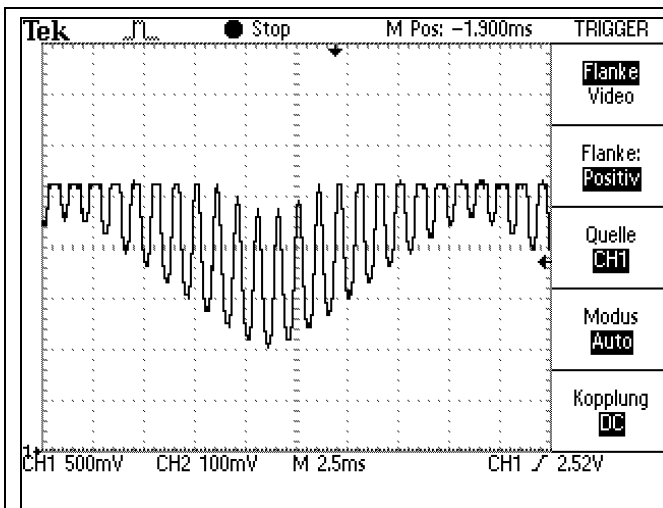

Figure 6 Useful signal with 1 kHz disturbance signal limited by the upper rail

2 Function

2.1 Method of measurement

An RF-immune probe (AS 100, AS 110, AS 120, AS 200, AS 300 or AS 350 optical fibre probe), of which the A/D (analog-to-digital) converter is an integral part, is autonomously operated in the DUT without interfering with the DUT's EMC conditions.

The only connection between the AS XXX probe and the DUT is an optical fibre that sends the measured values, which are continuously generated by the ADC as a serial data flow, to an optical receiver.

A D/A (digital-to-analog) converter (DAC) converts the digital sampling values back into an analog signal that can be evaluated by an oscilloscope.

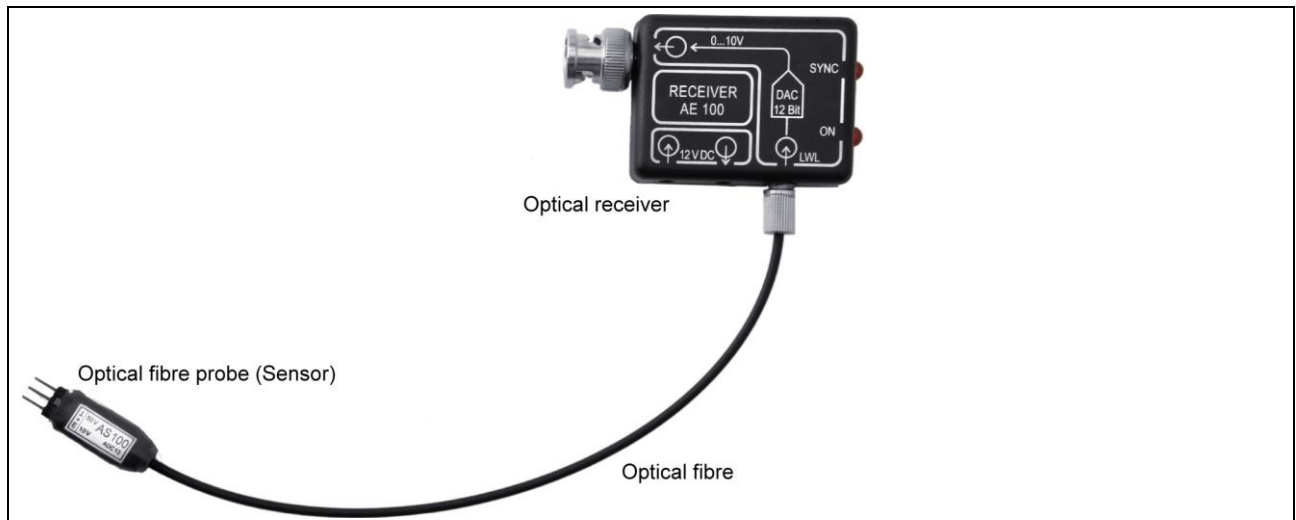

Figure 7 Optical fibre measuring system

2.2 AS XXX ADC probe (sensor)

The voltage that is applied to input E (Measuring input **Figure 8**) of the AS XXX probe (sensor) is converted to a serial data flow by an A/D converter.

The variable voltage divider generates the following control ranges:

Optical fibre probe (sensor)	Control range
AS 100	50 / 10 VDC
AS 110	10 / 1 VDC
AS 120	1 / 0.1 VAC
AS 200	50 / 10 VDC
AS 300	±10 VDC
AS 350	±50 VDC

In the AS 120 optical fibre probe a capacitive coupled amplifier is integrated with a low cut-off frequency of about 300 Hz. The sensor is protected against polarity reversal.

2.3 AE XXX DAC receiver

An optical receiver converts the optical fibre signal to a serial data signal. A sequential logic system synchronizes the receiver and controls the serial-parallel conversion of the measured values and the D/A conversion. Operational amplifiers are connected to the DAC output to filter and adjust the control ranges.

3 Operation

3.1 Connection of the probe (example AS 100) to the DUT

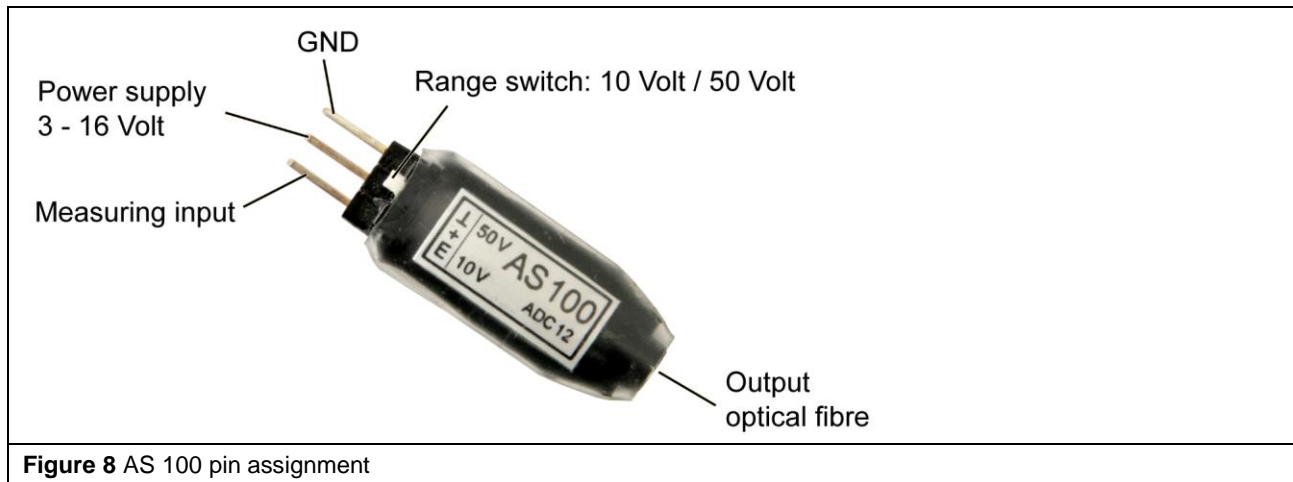

Figure 8 AS 100 pin assignment

Attention: Only connect and disconnect an AS XXX sensor when it is not subjected to any interference.

The connector between the optical fibre probe and the DUT has to be extremely short to ensure satisfactory measurements of burst and ESD under radiated RF interference conditions. Common prods and clips are too big.

The optical fibre probe has to be connected to the circuit board or IC via a socket to ensure the requisite small-scale set-up. Because the socket, rather than the probe itself, is soldered to the pins or lines, the measuring point can be quickly changed by plugging the probe into other sockets.

- To ensure the socket doesn't move, glue it to the circuit board or IC of the DUT. Connect the socket to the DUT via a CuL wire according to the sensor's pin assignment.
- Power is supplied via the DUT or a battery.

To avoid measuring errors pay attention:

- To position the AS XXX close to the DUT's GND areas.
- To solder the socket directly to the line to be measured with short connecting wires (10...20 mm).
- That the power is supplied by immediate signal environment via the pins or block capacitor of the relevant IC.
- To connect the GND of the socket and the GND of the module via a short connector (10...20 mm) when power is supplied by a battery. Position a block capacitor (approx. 100 nF) at the connecting point.

Basic rule: The closer the sensor (with its housing and GND connection) is positioned to the GND system of the DUT, the higher its disturbance immunity will be and the fewer disturbances will occur.



Figure 9 AS 100 connected to the DUT; position the AS 100 on the IC package if there isn't enough free space above GND

3.2 Starting the AE XXX optical receiver

- Connect the AE XXX to the oscilloscope (BNC plug).
- The receiver output supplies a zero-delay voltage of 10 V independent of the measuring range that is selected on the AS XXX. Thus, the vertical deflection on the oscilloscope should be 0.5-2 V/div.
- Connect the power supply to AE XXX (plug-in power supply unit) \Rightarrow lower LED "ON" must be on. Connect Sensor and receiver with the optical fibre \Rightarrow upper LED "Sync" must be on. Loose the clamped joint on the receiver, insert the optical fibre completely and slightly fasten the loose joint.

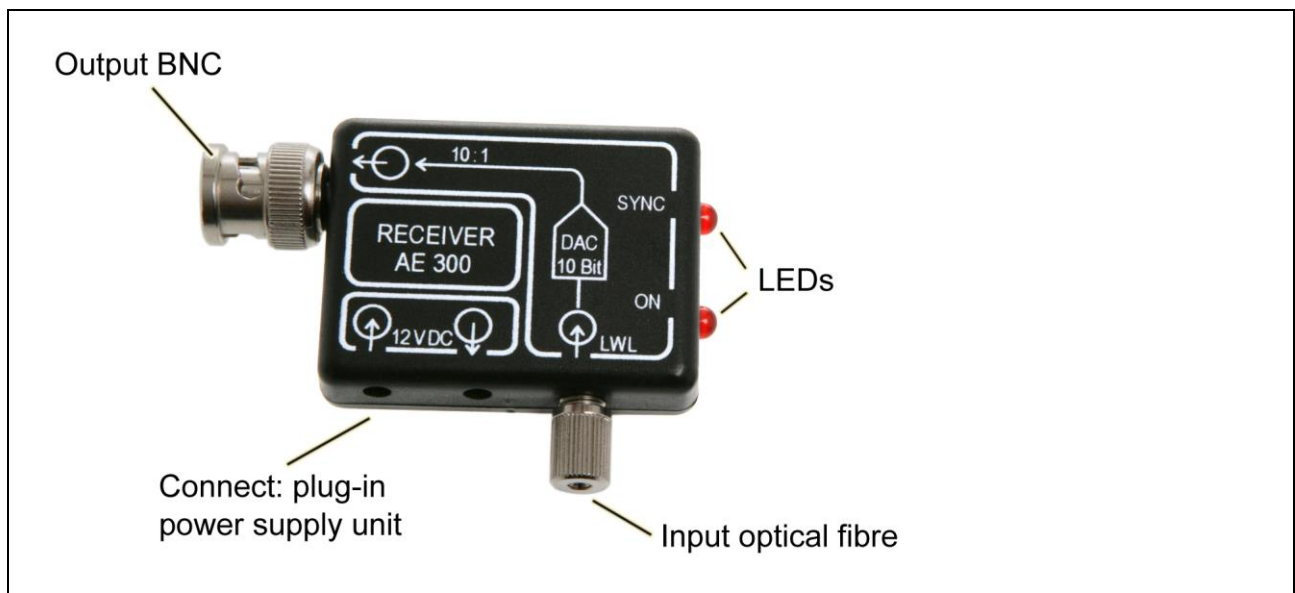

Figure 10 AE 300 connectors and displays

- The oscilloscope must show an output voltage and/or signal form that corresponds to that applied to the sensor input.

4 Safety instructions

When using a product from Langer EMV-Technik GmbH, please observe the following safety instructions to protect yourself from electric shock or the risk of injuries.

Read and follow the instructions in the user manual and keep it in a safe place for later reference. The device may only be used by personnel who are qualified in the field of EMC and who are fit to work with and possibly be influenced by disturbance voltages and (electric and magnetic) burst fields.

- Read the operating and safety instructions for all devices used in the set-up.
- Never use any damaged or defective devices.
- Carry out a visual check before using a measurement set-up with a Langer EMV-Technik GmbH product. Replace any damaged connecting cables before using the product.
- Never leave a product from Langer EMV-Technik GmbH unattended whilst it is in operation.
- The Langer EMV-Technik GmbH product may only be used for its intended purpose. Any other use is forbidden.
- People with a pacemaker are not allowed to work with this device.
- The test set-up should always be operated via a filtered power supply.
- **Attention! Functional near fields and interference emissions may occur when the probe is operated. The user is responsible for taking appropriate precautions to prevent any interference with the correct function of products outside the operational EMC environment (in particular through interference emissions. This can be achieved by:**
 - observing an appropriate safety distance
 - using of shielded or shielding rooms
- The disturbances that are injected into the modules can destroy the device under test (latch-up) if their intensity is too high. Protect the device under test by:
 - increasing the disturbance gradually and stopping when a functional fault occurs
 - interrupting the power supply to the device under test in the event of a latch-up.

Attention! Make sure that internal functional faults are visible from outside. The device under test may be destroyed due to an increase in the injection intensity if the faults are not visible from outside. Take the following precautions if necessary:

- monitor the representative signals in the device under test
- use a special test software
- monitor visible reaction of the device under test to inputs (reaction test of the device under test).

We cannot assume any liability for the destruction of devices under test!

5 Warranty

Langer EMV-Technik GmbH will remedy any fault due to defective material or defective manufacture, either by repair or by delivery of spare parts, during the statutory warranty period.

This warranty is only granted on condition that:

- the information and instructions in the user manual have been followed.

The warranty will be forfeited if:

- an unauthorized repair is performed on the product,
- the product is modified,
- the product is not used for its intended purpose.

6 Technical data

6.1 System

System	A100	A200	A300
Resolution	12 Bit	12 Bit	10 Bit
Conversion rate	125 ksps	3 Msps	12.5 Msps
Bandwidth	25 kHz	500 kHz	5 MHz
Transfer rate (optical fibre)	4 Mbps	48 Mbps	150 Mbps
Operating range (optical fibre)	1 – 20 m *		

* The device is delivered with an optical fibre of 1.5 m – 1 channel or 6 m – 2 channels
Please order other dimensions separately.

6.2 Sensors

Sensor type	AS 100	AS 110	AS 120	AS 200	AS 300	AS350
Measuring range, switchable	50 V / 10 VDC	10 V / 1 VDC	1 V / 0.1 VAC 300 Hz – 25 kHz	50 V / 10 VDC	±10 VDC	±50 VDC
Input resistance	100 kΩ	1 MΩ	1 MΩ	100 kΩ	100 kΩ	1 MΩ
Radiated immunity*	>200 V/m	>100 V/m	>100 V/m	>100 V/m	200 V/m	
Current consumption	ca. 3 mA			ca. 30 mA	70 – 30 mA	
Operating voltage	3 - 16 V				4.5 - 16 V	
Dimensions	(34 x 10 x 7) mm					
Operating temperature range	0 – 70 °C					

* Connectors ≤ 20 mm, on GND area, disturbances at output < 50 mV

6.3 Receivers

Receiver type	AE 100	AE 200	AE 300
Current consumption	ca. 30 mA	ca. 100 mA	90 mA
Operating voltage	12 - 16 V		12 V
Output voltage	0 - 10 V		±1 V
Dimensions	(71 x 47 x 14) mm		
Operating temperature range	0 – 70°C		

7 Scope of delivery

7.1 A100-1 / A200-1 / A300-1 (1-channel) set

Pos.	Designation	Type	Quantity
01	Optical receiver (DAC)	AE 100 / 200 / 300	1
02	Optical fibre probe (ADC), of choice *	AS XXX	1
03	Power supply unit	NT FRI EU / NT FRI US	1
04	Optical fibre	LWL Ø 2.2 mm, 1.5 m	1
05	Adapter socket 3-poles		3
06	Enamelled Copper Wire	Wire CuL	1
07	System case	AXXX-1 case	1
08	Quick guide	Analog qq	1
09	User manual	Analog m	1

* Further sensors are available on request and can be added to the set.

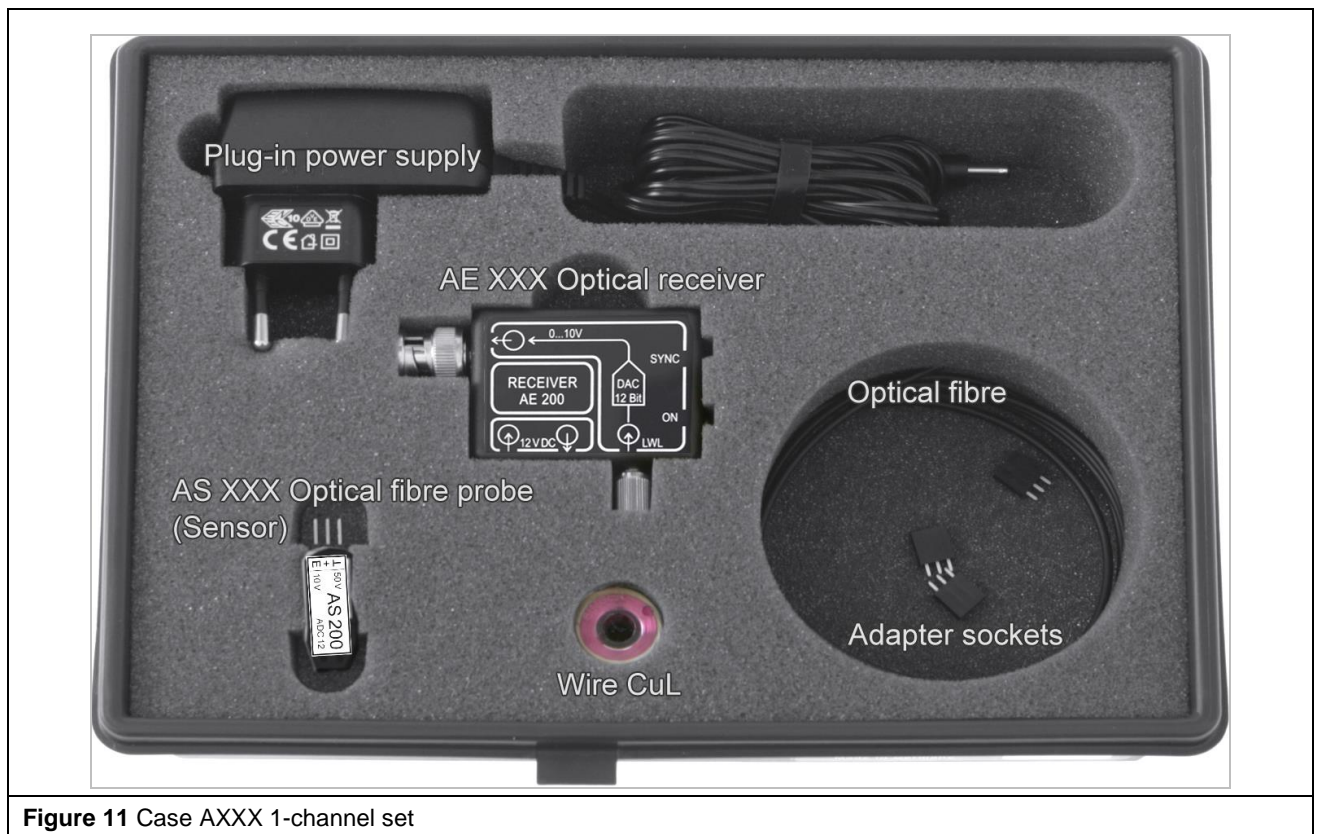

Figure 11 Case AXXX 1-channel set

7.2 A100-2 / A200-2 / A300-2 (2-channels) set

Pos.	Designation	Type	Quantity
01	Optical receiver (DAC)	AE 100 / 200 / 300	2
02	Optical fibre probe (ADC), of choice*	AS XXX	2
03	Power supply unit	NT FRI EU / NT FRI US	1
04	Power split cable 20 cm		1
05	Optical fibre	LWL Ø 2.2 mm 6 m	2
06	Adapter socket 3-poles		6
07	Enamelled Copper Wire	Wire CuL	1
08	System case	AXXX-2 case	1
09	Quick guide	Analog qg	1
10	User manual	Analog m	1

* Further sensors are available on request and can be added to the set.



Figure 12 Case AXXX 2-channels set

This document may not be copied, reproduced or electronically processed, either in its entirety or in part, without the prior written permission of Langer EMV-Technik GmbH. The management of Langer EMV-Technik GmbH assumes no liability for damage that may arise from using this printed information.

Langer EMV-Technik-GmbH

Noethnitzer Hang 31
DE-01728 Bannewitz
www.langer-emv.com

Tel.: +49(0)351/430093-0
Fax: +49(0)351/430093-22
mail@langer-emv.de